



**AQUAEDGE™**

# Carrier AquaEdge® 19MV Centrifugal Chiller

EquiDrive™  
Back-to-Back Compressor

Magnetic Bearing

Greenspeed™  
Intelligence

Cooling Capacity: 1055~2462kW





In 1998, Time magazine named Dr. Carrier one of its 20 most influential builders and titans of the 20th century.

Carrier is a leading global provider of innovative HVAC, refrigeration, fire, security and building automation technologies. Supported by the iconic Carrier name, the company's portfolio includes industry leading brands such as Carrier, Kidde, Edwards, LenelS2 and Automated Logic.

Carrier's businesses enable modern life, delivering efficiency, safety, security, comfort, productivity and sustainability across a wide range of residential, commercial and industrial applications.



## Model Number Nomenclature

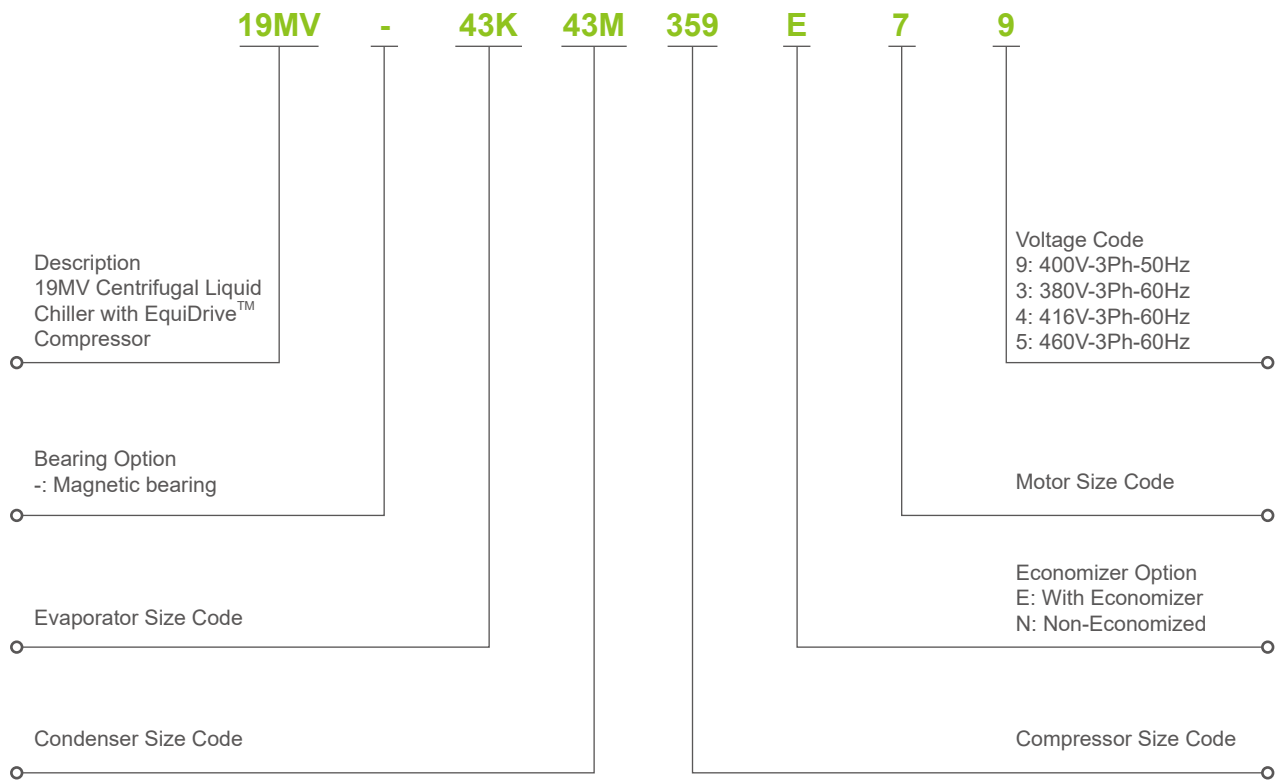

## Cooling Capacity

300-700Ton

## 19MV Introduction

AquaEdge® 19MV is the latest generation of variable speed centrifugal chiller which has high operation efficiency and reliability that leads the industry. The chiller can be applied in both comfortable and process cooling scenarios such as office building, hospitality, healthcare, public facility, data center and industrial manufacturing to realize energy saving and improve operation efficiency .

General features:

- ✔ Standard design based on environmentally sustainable refrigerant R-134a and offers low GWP refrigerant R-513A as an option
- ✔ Back-to-back two-stage centrifugal compressor
- ✔ Dual expansion valves enable 19MV stably operate across wide operation envelope
- ✔ AHRI certified part load efficiency 11.4kW/kW
- ✔ The chiller meets GB19577 class I energy efficiency standard
- ✔ Advanced Carrier® SmartVu™ control system



## Reliable

- The standard unit of 19MV chiller is configured with magnetic oil free centrifugal compressor, which eliminates oil lubrication and recovery system required by conventional centrifugal chillers. Customers won't be troubled by oil related failures as well as maintenance cost.
  - Advanced back-to-back compressor design naturally balances both radial and axial thrust on shaft.
  - Standard UPS and hybrid ceramic touchdown roller bearings ensure the reliability of magnetic bearings even in case of unexpected power loss.
  - High-speed direct drive motor design reduces transmission loss.
  - Cooling of semi-hermetic motor is accomplished by spraying liquid refrigerant on the motor windings in which way the potential shaft seal leaks and refrigerant loss can be effectively eliminated.
- The economizer is configured with dual expansion valves which are motivated by asynchronous motor with more than 3000 steps thus to realize accurate flow control of refrigerant.
- Double-grooved tube sheet holes eliminate the possibility of leaks between the water and refrigerant circuits, increasing product reliability.
- 19MV chiller can stably operate down to 10% load under constant cooling water temperature.
- 19MV can quickly achieve 100% capacity upload within 150s\* after power loss which provides added reliability for critical facilities such as data centers.

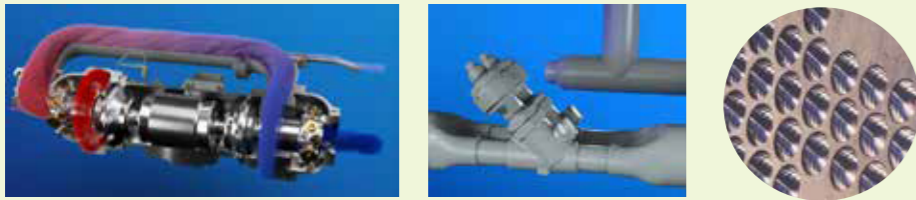

\* Full load capacity is based on current, please contact local agencies for other assumptions.



## Efficient

- The design of two stage back-to-back centrifugal compressor integrated with middle stage economizer and the sub-cooler in the condenser improve both cooling capacity and efficiency.
  - Standard unit design of magnetic bearing and high-speed direct drive design eliminate the mechanical loss caused by friction thus to improve mechanical efficiency.
  - Compared to conventional induction motor, the configured permanent magnetic motor may deliver much higher efficiency at both full load (98%) and part load conditions.
  - Compressor is designed with back-to-back two stage which improves part load efficiency greatly.
  - The economizer is configured with dual expansion valves which enables chiller high efficiency under different conditions with accurate control.
- The adoption of high-performance tubing in heat exchanger and optimized water box and water side bundle enables higher chiller heat transfer efficiency and less water pressure drop thus to reduce system energy consumption.
- Greenspeed™ variable speed control gives an instantaneous control of compressor speed to accommodate building load changes perfectly, which ensures the chiller always operating efficiently especially at part load.

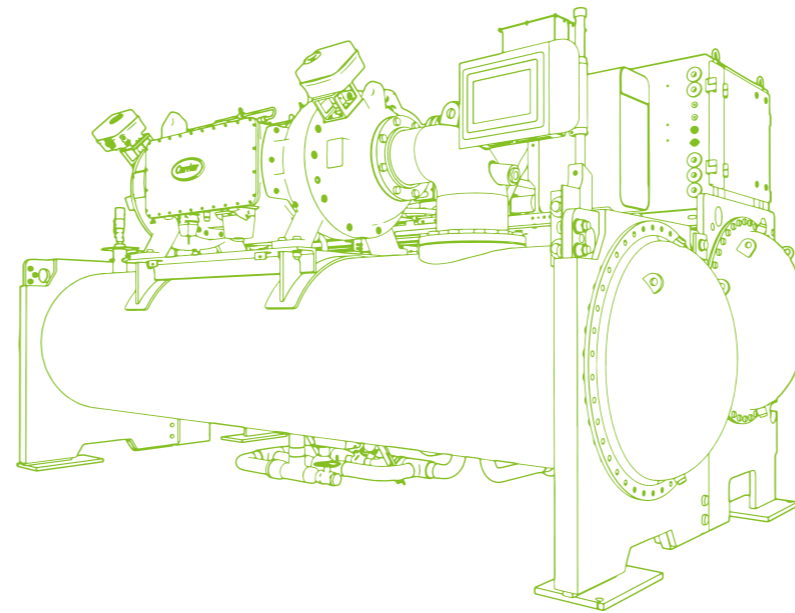

## Sustainable



- Designed specifically for chlorine-free R-134a refrigerant (the environmentally balanced refrigerant with zero ozone depletion potential).
- New low Global Warming Potential (GWP) refrigerant R-513A is provided as option to further diminish the potential direct impact on global warming.
- The outstanding energy efficiency of 19MV chiller leads to lower electrical power consumption and significant reduction of related CO<sub>2</sub> emissions.
- The compressor and motor in 19MV are semi-hermetically sealed to eliminate the potential shaft seal leaks and refrigerant loss giving 19MV one of the industry's lowest leak rates at 0.1% p.a.

## Quiet



- Magnetic bearings, refrigerant-cooled semi-hermetic motor, direct drive, optimized flow channel, all these features contribute to the overall compressor sound reduction. The noise level of chiller under AHRI condition is less than 80dBA.
- Greenspeed™ variable speed control adaptively turns down impeller speed at part load for better acoustic performance.
- 19MV chillers can meet 18001 standard recommended by Occupational Health and Safety Advisory Services (OHSAS).

## Flexible



- Positive pressure design can save valuable mechanical room space with reduced chiller size compared with low pressure design. In addition, it eliminates the need for purge system to save the cost for customer.
- System layout of 19MV chiller is well optimized with compact footprint and the bolt connection modular design enables easier installation without disassembly in retrofit projects.
- Patented re-locatable control panel could be installed at multiple corners of the chiller, which makes the layout of chillers more flexible to fit the site conditions.
- Miscellaneous optional offerings (such as marine water box) help to facilitate daily maintenance on jobsite.

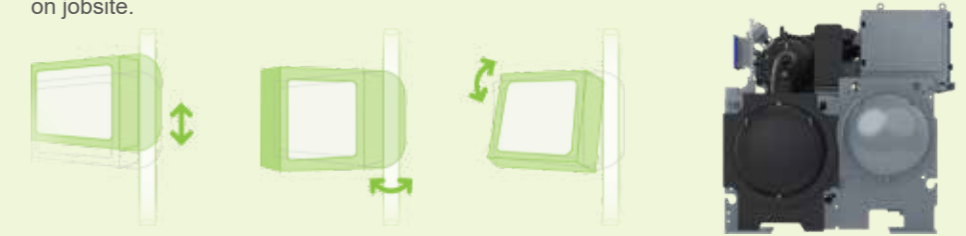

## Smart



- Carrier SmartVu™ control - color touch screen, intuitive menu, animated component level interface, graphic trending, auto pushed alarm mail, smart password and up to 10 languages for choice.
- Multiple remote access methods present the users a flexible way to monitor and control the chillers.
- Carrier SMART Service Service supports online data management and analysis, daily and key performance reports, prognostics and preventative maintenance, which will help the users continuously optimize the chiller and system operation.



# Carrier SmartVu™ Control

## User-friendly Interface

AquaEdge® 19MV centrifugal chiller equips with the latest Carrier SmartVu™ control system which provides powerful control and monitoring functions for smart chiller operation. The control system applies a 10 inch high resolution colorful touch screen, which supports up to 10 languages, and real time display of operation parameters with pictures makes it more user-friendly.

## Smart Operation

- Carrier SmartVu™ control system provides customer the smart password function to avoid any setting change without authorization.
- When the chiller receives a start-up command, the controller will conduct following pre-start safety checking, to ensure parameters like condensing pressure, bearing temperature, motor winding temperature, discharge temperature, evaporator saturated temperature and average line voltage, etc. are in normal condition.
- Optimized intelligent and dynamic control algorithm ensures effective and reliable operation. Carrier SmartVu™ control system can not only monitor and display main operation parameters with real-time trend, but also record the history data of each key component.
- Carrier SmartVu™ control system provides comprehensive protections for long-term stable operation, such as surge protection, overvoltage and overcurrent protection, discharge temperature overheat protection, bearing temperature overheat protection, evaporator and condenser anti-freeze protection, low discharge superheat protection etc..
- The optional Envelope Stability Control is an advanced solution to balance the chiller efficiency and reliability at very low load. The controller optimizes compressor speed, inlet guide vane position and stabilizer valve position to find the most efficient operating point throughout the operating range without compromising the chiller stability in real time.
- Optional Master-Slave function enables two chillers work in Master-Slave mode with CCN communication. Two chillers can be in series or parallel connection. Carrier patent control algorithm can make two chillers achieve a good balance between efficiency and stability.

## Intelligent Diagnosis

- Carrier SmartVu™ control system integrates with effective failure diagnostic functions. Once control system detects failure, the alarm will be initiated and related codes will be recorded in alarm menu and it will be saved by control system automatically. Only Carrier certified service technician can read or deleted it by Carrier Service Tool.
- Additional pre-diagnostic function is specialized for maintenance purpose, which could help guide customer replace the parts periodically for safety operation.
- Email alarm function is standard integrated in Carrier SmartVu™ control system, which can automatically send out an email with one or more alarm information to specified email address once system goes wrong if Carrier SmartVu™ controller is connected to the Internet.

## Easy Connection with Building Automation System

- Carrier SmartVu™ control panel supports BACnet or Modbus protocol with which chiller can seamlessly connect with the Building Automation System or the i-Vu™/WebCTRL Control network.
- With the powerful i-Vu™ Link (optional), user can integrate all plant equipment into i-Vu™ Building Automation System. The i-Vu™ Building Automation System provides everything user needs to access, manage, and control your building, including the powerful i-Vu™ user interface, plug-and-play BACnet or Modbus controllers and state-of-the-art Carrier equipment.
- Carrier provides WebCTRL as an additional option to provide similar function like i-Vu™ Link. If you have any questions, please contact with Carrier local agents.

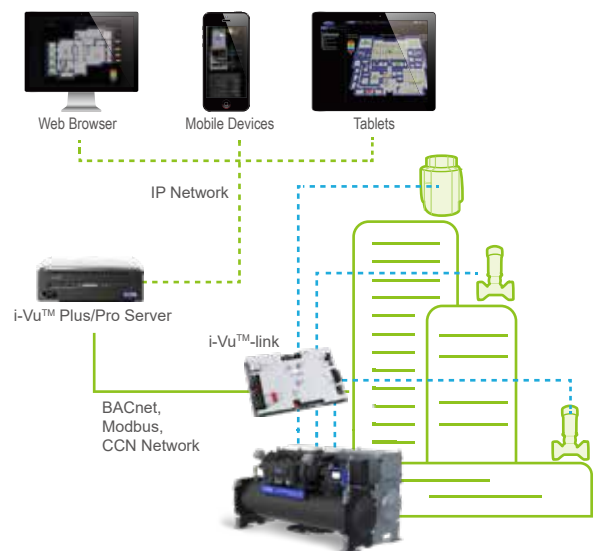

The i-Vu™ Building Automation System

## Smart Chiller

Using wireless cellular communications technologies, Carrier SMART Service continuously streams operating data to the cloud in real time directly from your chiller's Carrier SmartVu™ controller. The data is then captured within our IoT platform for ongoing insight into your chiller's health.

Features:

- ✔ Integrated equipment sensors that capture key operating data
- ✔ Secure wireless connectivity to Carrier's cloud-based IoT platform
- ✔ Persistent and reliable data transmission



## Smart Cloud

Carrier SMART Service continuously stores and assesses equipment operating data and service history, comparing it to established values for analytics and data validation. It compares this data to design specifications and matches it against allowable ranges, allowing Carrier to deliver pre-emptive service solutions as needed.

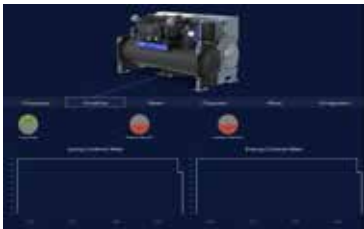

An added benefit, by phases and ultimately, all Carrier service agreement customers will have access to the Carrier SMART Service Community – a home page that helps you manage your HVAC system assets, such as initiating a service or maintenance request, monitoring work progress, planning for upcoming tasks or reviewing prior work orders. Combined with the information provided by the equipment dashboard, the Community ensures every Carrier service agreement customer has the ultimate in asset management capability.

Features:

- ✔ Complete visibility into your system's performance, energy usage and service history
- ✔ Advanced diagnostics and analytics providing actionable insights

## Smart Technician



Carrier SMART Service changes how equipment is serviced and maintained. Carrier service technicians now utilize mobile devices with remote access to put real-time chiller data and service history in the palm of their hands. With advance notification of problems, technicians arrive at the jobsite more informed, which leads to faster problem resolution and reduced mean time to repair.

Features:

- ✔ Advance notification
- ✔ Remote detection and diagnosis

## Performance Data (380V-3Ph-50Hz)

Model	Chiller						Evaporator			Condenser			Unit Dimensions			Weight		
	Cooling Capacity	Input Power	Full load COP <sub>R</sub>	NPLV IP	Motor Rated Amps	Flow Rate	Pressure Drop	Water Connection	Flow Rate	Pressure Drop	Water Connection	Length	Width	Height	Operating	Rigging(w/o Refrigerant)	Refrigerant Charge	
	Tons	kW	kW	kW/kW	kW/kW	A	l/s	kPa	mm	l/s	kPa	mm	mm	mm	mm	kg	kg	kg
19MV-31K31M339E39	350	1231	207.1	5.944	10.76	358	58.7	61.2	DN200	69.2	56.4	DN200	4075	1804	1987	7839	6565	592
19MV-41J41K349E59	400	1407	233.7	6.019	10.90	402	67.1	47.9	DN200	78.9	51.2	DN200	4092	1802	2070	8891	7363	704
19MV-41K41M359E59	450	1583	260.9	6.066	11.07	455	75.5	52.2	DN200	88.7	47.0	DN200	4092	1802	2070	9176	7544	726
19MV-43K43M369E59	500	1758	283.3	6.208	11.27	499	83.9	72.0	DN200	98.2	63.9	DN200	4702	1925	2070	10190	8319	855
19MV-51H51L379E59	550	1934	317.9	6.084	11.09	569	92.2	60.4	DN250	108.3	45.0	DN250	4118	1994	2161	10363	8495	794
19MV-51J51M389E79	600	2110	350.2	6.026	11.04	623	100.6	58.8	DN250	118.4	48.3	DN250	4118	1994	2161	10615	8654	827

**Note:**

- The above selections are based on entering/leaving chilled water temperature: 12/7°C; entering/leaving cooled water temperature: 32/37°C. Cooler fouling factor is 0.0176 m<sup>2</sup>C/kW and condenser fouling factor is 0.044 m<sup>2</sup>C/kW.
- Carrier will select specific models using computer on different requests for tonnage, lift, and efficiency. For details, please contact local agencies.
- Standard water box pressure is 1.0Mpa. For more requirements, please contact local agencies.
- The above selections are based on main power 380V-3Ph-50Hz, please contact local agencies for more power options.



## Typical Piping and Wiring

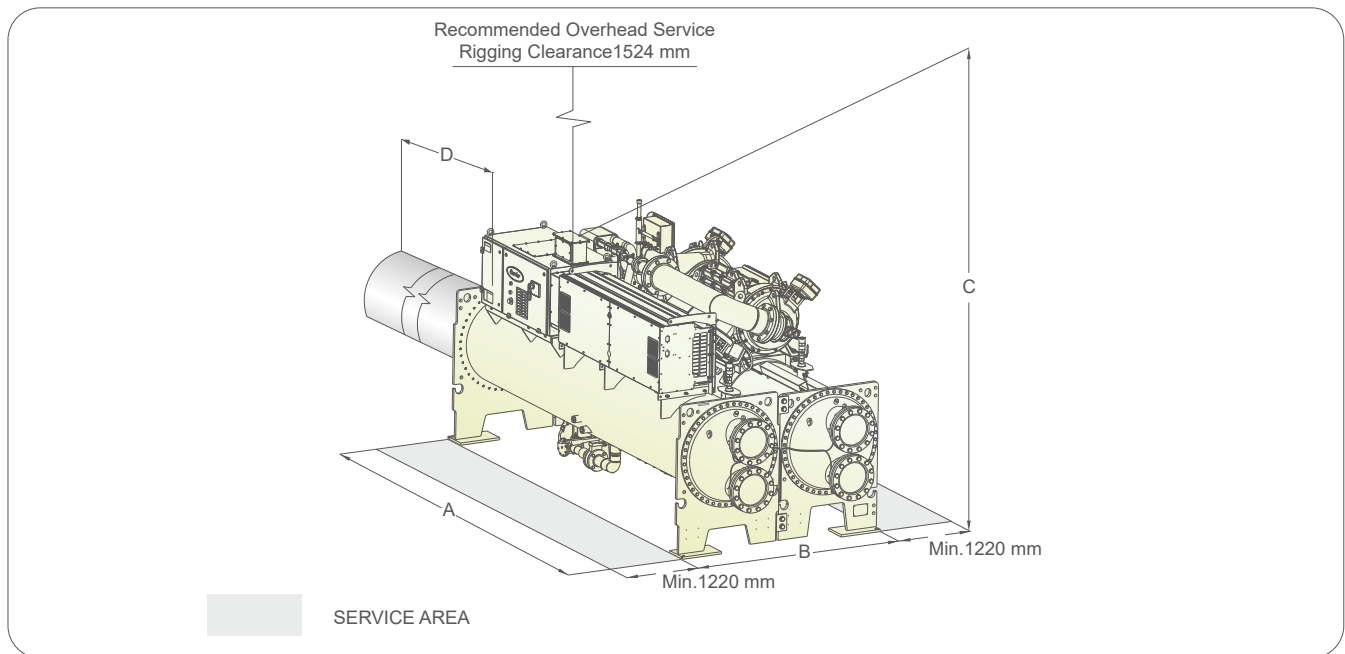

Evaporator Size	Condenser Size	A-length (2 passes)	B-Width	C-Height	D-Tube Re-moval Space for Either End
		mm	mm	mm	mm
31B-31W	31B-31M	4075	1804	1987	3410
33B-33W	33B-33M	4685	1804	1987	4020
41B-41W	41B-41M	4092	1925	2070	3410
43B-43W	43B-43M	4702	1925	2070	4020
51B-51W	51B-51M	4118	1994	2161	3410
53B-53W	53B-53M	4728	1994	2161	4020

## Typical Piping and Wiring (with Free-standing Starter)

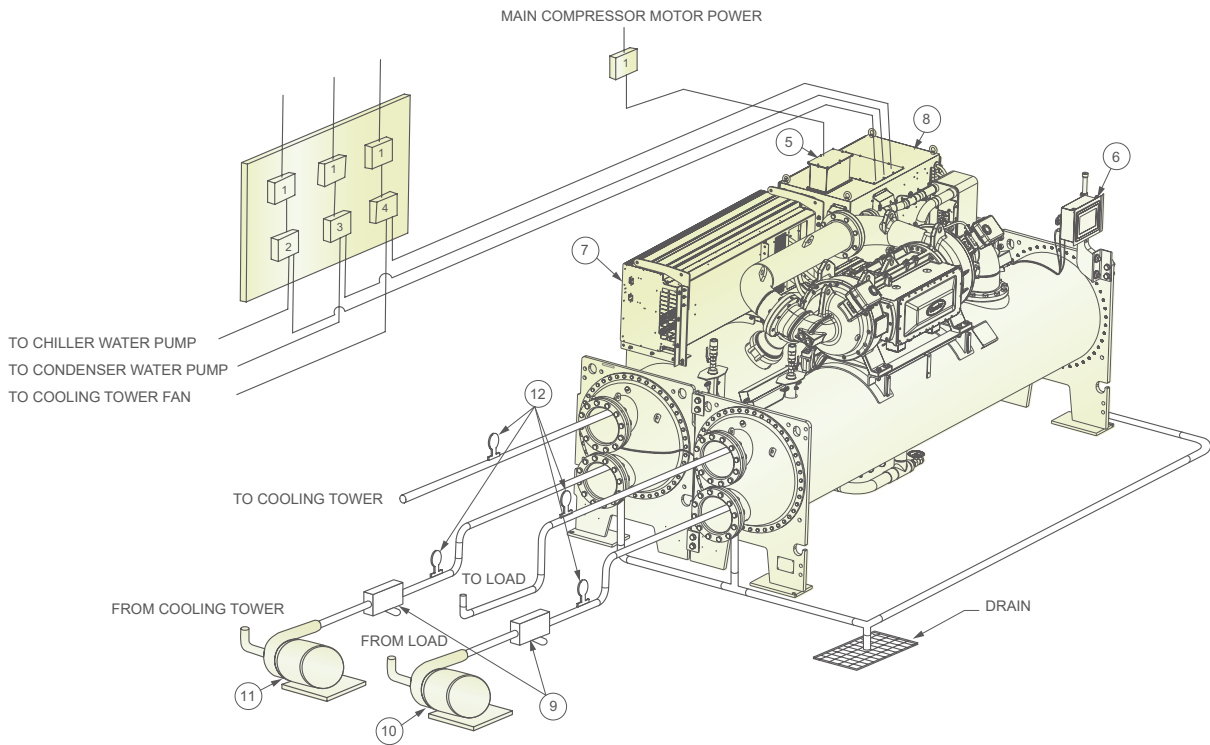

### LEGEND:

- |  |                        |  |
|--|------------------------|--|
| 1. Disconnect                                    | 6. HMI                 | 11. Condenser Water Pump                       |
| 2. Chilled Water Pump Starter                    | 7. Unit-Mounted VFD    | 12. Pressure Gages                             |
| 3. Condenser Water Pump Starter                  | 8. Power Panel         | 13. Local Disconnect (hidden - in power panel) |
| 4. Cooling Tower Fan Starter (Low Fan, High Fan) | 9. Strainers           |  |
| 5. Tophat  | 10. Chilled Water Pump |  |

### NOTES:

- Wiring and piping shown are for general point-of-connection only and are not intended to show details for a specific installation. Certified field wiring and dimensional diagrams are available on request.
- All wiring must comply with applicable codes.
  - Provide a means of disconnecting branch feeder power to chiller. Provide short circuit protection and interrupt capacity for branch feeder in compliance with all applicable codes.
  - Metal conduit must be used for the power wires, from chiller to branch feeder.
  - Line side power conductor rating must meet VFD nameplate volt- age and chiller full load amps (minimum circuit ampacity).
  - Lug adapters may be required if installation conditions dictate that conductors be sized beyond the minimum ampacity required. Lugs will accommodate the quantity (#) and size cables (per phase) as follows. If larger lugs are required, they may be purchased from the manufacturer of the circuit breaker. See Conductor Usage table for lug sizes.

VFD size	LUG CAPACITY (PER PHASE)		LUG CAPACITY (GROUND)	
	MAX QTY	MAX CABLE SIZE	MAX QTY	MAX CABLE SIZE
DD395, DD480, DD588	2	300mm <sup>2</sup>	1	240mm <sup>2</sup>
DE658, DE745, DE800, DE990	2	300mm <sup>2</sup>	1	240mm <sup>2</sup>

- Compressor motor and controls must be grounded by using equipment grounding lug provided inside unit-mounted VFD enclosure.
  - Control wiring required for Carrier to start pumps must be provided to assure machine protection. If primary pump and flow control is by other means, also provide a parallel means for control by Carrier. Failure to do so could result in machine freeze-up or overpressure.
- Wiring not shown for optional devices such as:
    - Remote Start/Stop
    - Remote Alarms
    - Optional Safety Device
    - 4 to 20 mA Resets
    - Optional Remote Sensors
  - Thermometer (0-50°C) and pressure gauge (0-1MPa or 2MPa) must be installed at inlet and outlet of the pipes.
  - Operating environment — Chiller should be installed in an indoor environment where the ambient temperature is 40 to 104°F (4 to 40°C) with a relative humidity (non-condensing) of 95% or less. To ensure that electrical components operate properly, do not locate the chiller in an area exposed to dust, dirt, corrosive fumes, or excessive heat and humidity.
  - Strainers are typically located on the suction side of the water pumps. It is acceptable to install strainers on either side of the pump.
  - It is suggested that an oxygen content monitor be installed in the machine room for safety, which will give an alarm when the oxygen content is less than 19.5%.



# Types of Base Isolation

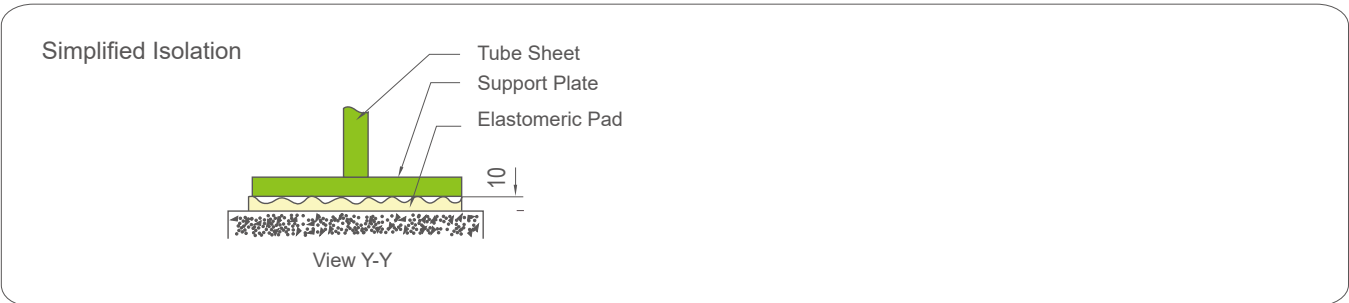
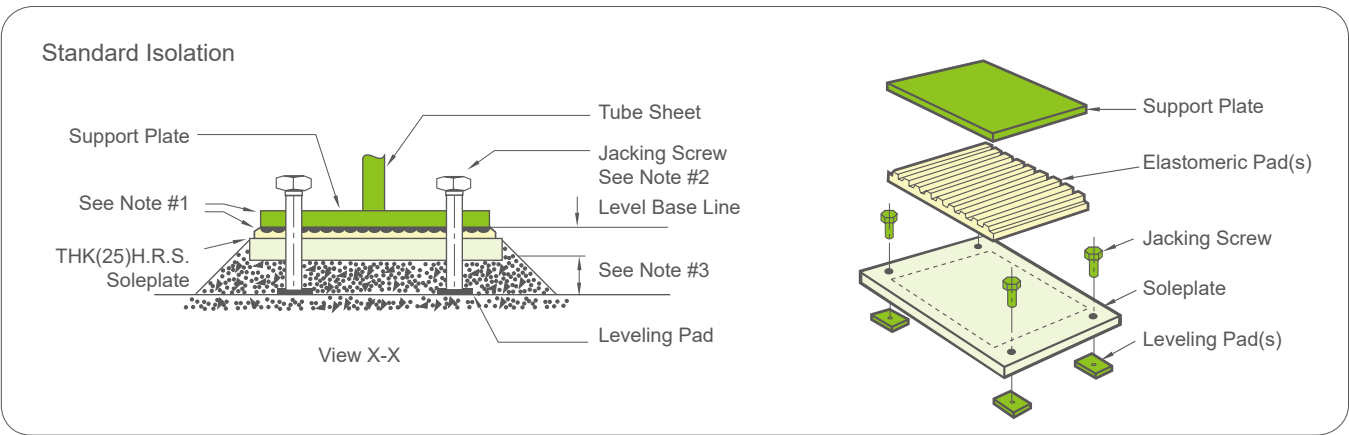
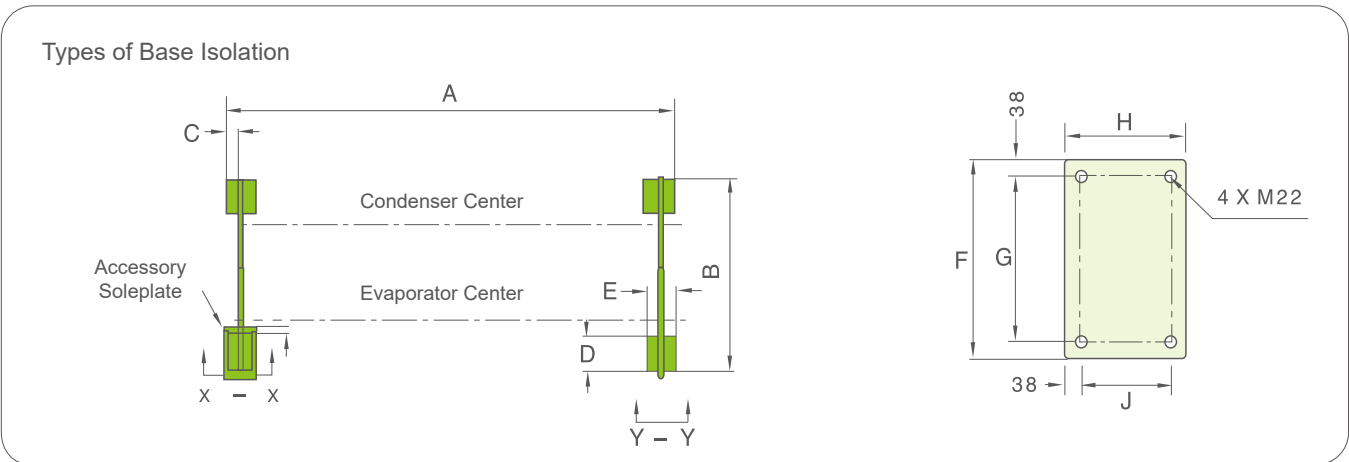





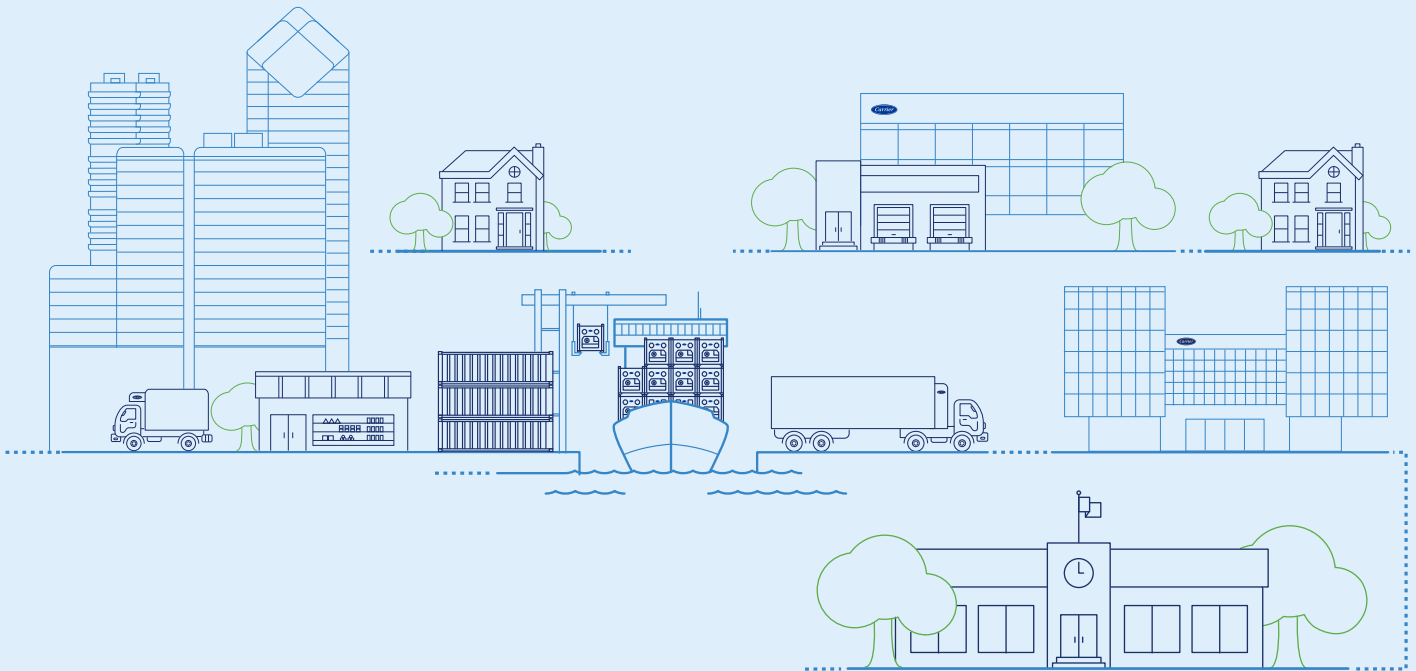

- Notes:
1. Accessory soleplate package includes 4 soleplates, 16 jacking screws, and 16 leveling pads.
  2. Jacking Screws should be removed after the grout has set.
  3. Thickness of grout varies, depending on the amount necessary to level chiller.

Evaporator/ Condenser model	A	B	C	D	E	F	G	H	J
	mm	mm	mm	mm	mm	mm	mm	mm	mm
31B-31W/31B-31M	3587	1753	92	387	229	540	464	254	178
33B-33W/33B-33M	4197	1753	92	387	229	540	464	254	178
41B-41W/41B-41M	3587	1753	92	387	229	540	464	254	178
43B-43W/43B-43M	4197	1753	92	387	229	540	464	254	178
51B-51W/51B-51M	3587	1969	92	387	229	540	464	254	178
53B-53W/53B-53M	4197	1969	92	387	229	540	464	254	178

# Our 2030 Sustainability Goals





## OUR PLANET

-  Invest over **\$2B** to develop **healthy, safe and sustainable building and cold chain solutions** that incorporate **sustainable design principles and reduce life-cycle impacts**.
-  Reduce **energy intensity** by 10% across our operations.
-  Deliver **zero waste** to landfill from manufacturing locations.
-  Achieve **carbon-neutral** operations.
-  Achieve **water neutrality** in our operations, prioritizing water-scarce locations.
-  Establish a **responsible supply chain program** and assess key factory suppliers against program criteria.

## OUR PEOPLE

-  Exceed benchmark **employee engagement**.
-  Achieve a **diverse workforce** that represents the communities in which we live and work.
-  Achieve **gender parity** in senior leadership roles.
-  Foster the growth of **employee resource groups** to drive social impact.
-  Maintain world-class **safety metrics**.

## OUR COMMUNITIES

-  Positively impact communities through enabling access to **safe and healthy indoor environments, alleviating hunger and food waste, and volunteering our time and talent**.
-  Invest in **STEM education** programs that promote **diversity and inclusion**.
-  Promote **sustainability** through education, partnerships and climate resiliency programs.



REDUCE OUR CUSTOMERS' CARBON FOOTPRINT BY MORE THAN

# 1 GIGATON.

# HEALTHYBUILDINGS



[www.carrier.com](http://www.carrier.com)

The Manufacturer reserves the right to change any product specifications without prior notices  
© ALL Rights Reserved, Carrier® is a registered trademark of Carrier corporation.

Version:	CAT-AQUAEDGE-19MV_202205_01
Supersede:	CAT-AQUAEDGE-19MV_202205_01
Effective Date:	May, 2022