

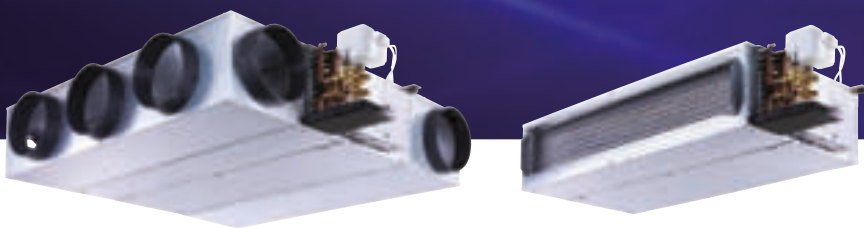

AIR CONDITIONING & HEATING SOLUTIONS

SIMPLICITY **OR** FULL MODULARITY ?

IDROFAN, BECAUSE YOU SHOULD NOT HAVE TO CHOOSE.



Hydronic ducted fan coils

Cooling capacity 0.6 kW - 12 kW
Heating capacity 0.8 kW - 17 kW

42NL & 42NH

IDRO

Carrier solutions based on **experience and expertise**

Carrier Legacy

Since Willis Carrier developed the world's first modern air conditioning system in 1902, Carrier teams have been designing solutions tailored to each customer's requirements. Over time, Carrier has been recognised as a pioneer in the design and manufacture of heating, ventilation and air conditioning (HVAC) solutions with sustainable performance and, equally important, for its commitment to first class service.



Carrier Commitment

■ **Quality**

Carrier quality and reliability are incorporated and guaranteed in all products and systems. Products undergo extensive tests before delivery and are certified by internal organisations to ensure the highest levels of safety and quality.

■ **Sustainability**

Carrier continuously works to improve the environmental performance of its products and services, operations and its culture to help lead the way to environmental sustainability. Sustainability is a growing concern to the building sector and a key factor for building owners and operators. A high-efficiency air conditioning system with a low carbon footprint is a must to support green building design.

■ **Performance**

Carrier strives for continuous growth to reinforce its leadership position, continuously improving the productivity and quality of its assets and resources.

■ **Service Excellence**

The Carrier Service delivery model maintains a reputation for high customer satisfaction and delivers service excellence with strong communication channels, the top technicians in the industry, continuous improvement of contracts and a highly experienced management team.

■ **Innovation**

Carrier is a company of ideas, committed to research and development, whose founder still inspires the company to reach the next innovative, powerful and marketable idea. AdvanTE³C, a global group of Experts in Efficiency and Environment, supports customers around the world in developing strategic, energy-efficient and custom-engineered building solutions.

■ **Expertise**

Carrier delivers global solutions across the broadest range of air conditioning, ventilation and heating applications. With a proven track record of leadership and industry expertise, Carrier provides a portfolio of market-leading products and services.

SIMPLICITY

The simplicity of the range for easy use

■ Industry standard

With an installed base of more than a million units, **the Idrofan range has become the standard in the fan coil cooling market.** The quality and reliability of the equipment is backed by Carrier's recognised expertise in services. Its high quality design has been developed thanks to the company's experience in the field and its performance is validated by Eurovent certification.

■ Versatility

The 42NL & 42NH wide range can meet every need. It offers either low or high external static pressure capability and is available in a wide choice of plenums and spigot diameters. It meets customer demands in terms of both heating and cooling capacity (from 0.5 to 10 kW) and noise levels.

■ Serviceability

The 42NL & 42NH units are designed for easy installation, in any type of false ceiling in hotel, office, shop or restaurant applications. The units offer direct access to air filter, water coil, drain pan and fan motor assembly, for easy maintenance and compliance with local hygiene regulations.

THE STANDARD
IN INDIVIDUAL
COMFORT AIR
CONDITIONING
SOLUTIONS

ONE PRODUCT
FOR MANY
APPLICATIONS

EASY
INSTALLATION
IN MANY
CONFIGURATIONS

&

FULL MODULARITY

The right choice for all applications

■ Modular design

Due to a large range of air distribution solutions (rectangular flanges, compact or large plenums, multiple spigots...), sizes and control solutions, **the 42NL & 42NH are designed to adapt to all room sizes and configurations.**

■ Silent solutions

With its acoustic insulation and very low noise fan motor, the 42NL & 42NH range makes silent operation a reality. Its Low Energy Consumption (LEC) motor with variable fan speed control ensures improved noise comfort levels compared to a multi-speed motor - the airflow is automatically adjusted, from 0 to 100%, in order to perfectly meet the occupants' needs. With a Carrier Water Terminal Controller (WTC), maximum fan speed can also be limited to enhance sound level management even further.

■ Intelligence

The 42NL & 42NH range ensures optimum operations through a wide range of smart controllers, including electronic thermostats, the Network Terminal Controller (NTC) Aquasmart® and the new WTC, which manages water valve and fan speed simultaneously **for minimum energy consumption and maximum comfort.** Other smart WTC options include an automatic balancing water valve and a motorised fresh air valve with a CO₂ sensor for optimum air quality.

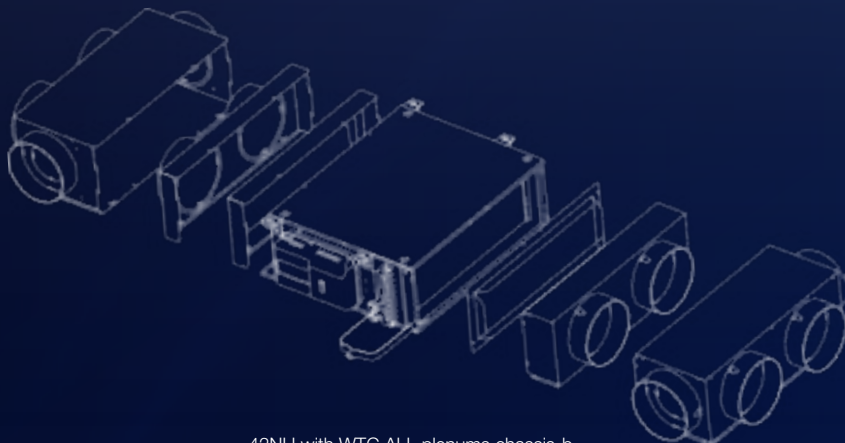

42NH with WTC ALL plenums chassis-b

Technical Insight

Hydronic ducted fan coil 42NL & 42NH

42NH with plenum outlet and inlet configuration



Control solutions

- Thermostat electronic
- NTC Aquasmart®
- WTC controller BACnet & LON

Large choice
of plenums and spigots

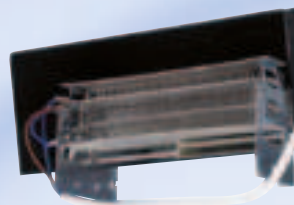

Electrical heater

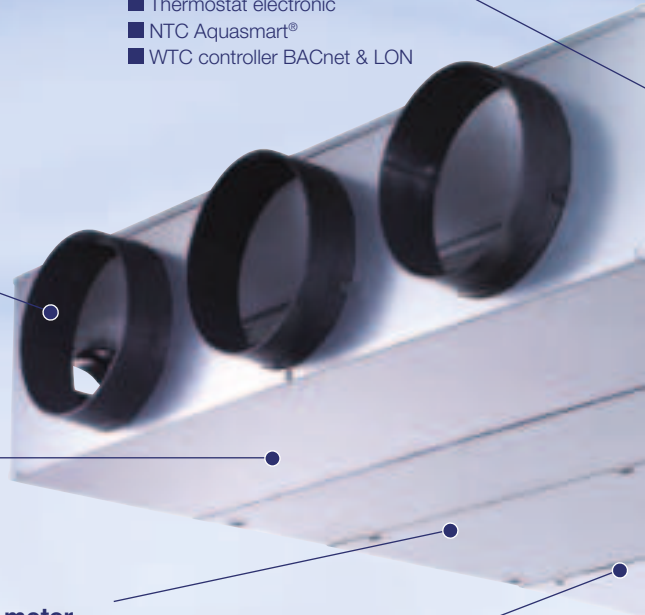

Fan motor

- AC multi-speed motor (5 to 6 speeds)
- LEC variable-speed EC motor

Filter solutions

- G1 (standard)
- G3
- M5 (for higher indoor air quality)

AUTOMATIC HYDRAULIC BALANCING WATER VALVE

The automatic hydraulic balancing water valve is a cutting-edge new feature. With its integrated differential pressure controller **it prevents pressure fluctuations and ensures constant cooling or heating capacities.** With easy presetting of volumetric flow and straightforward assembly, the water valve allows **simplified mounting, commissioning and hydraulic balancing.**



- 1 Control valve actuator
- 2 Infinite presetting of required maximum volumetric flow
- 3 Integrated differential pressure controller
- 4 Pressure test points

KEY FEATURES

- **Large choice of air distribution configuration:** free return/supply, rectangular flanges, compact or large return/supply plenums, "U" configuration together with multiple spigot sizes.
- **Improved acoustic comfort:** automatic air flow adjustment from 0 to 100% allows better sound level management.
- **Easy maintenance:** direct access to air filter, water coil, drain pan and fan motor assembly.
- **Large controller range:** electronic thermostats, NTC AquaSmart and WTC controller.

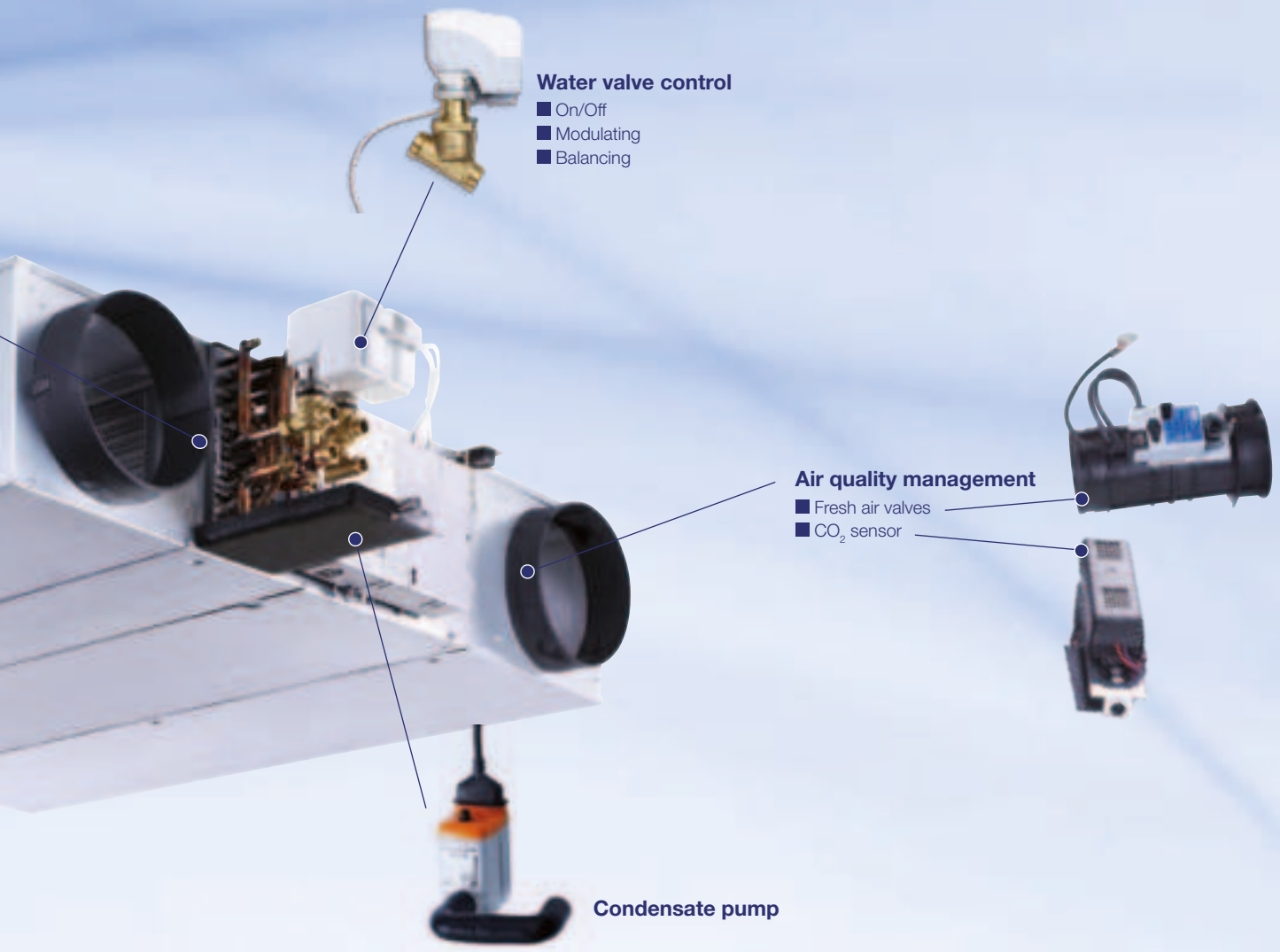

Water valve control

- On/Off
- Modulating
- Balancing

Air quality management

- Fresh air valves
- CO₂ sensor

Condensate pump

■ **Energy savings:** the optional low energy consumption (LEC) brushless EC motor reduces fan coil energy consumption by up to 50%, compared to an AC motor, making it easier to meet the new building energy management regulations.

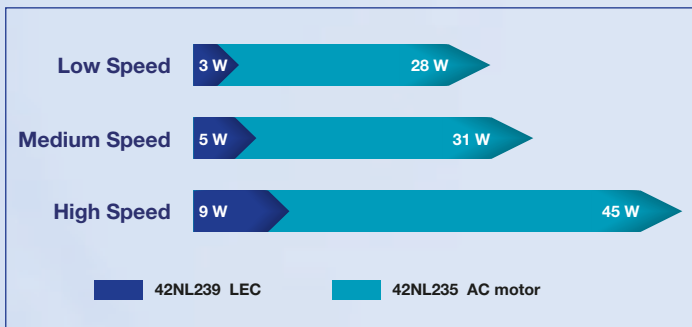

SOURCE: Carrier estimates based on testing by Carrier Laboratory.

■ **Modularity:** With two available versions, the fancoil is able to address all applications. The 42NL version is optimised for simple soffit installations while the 42NH is optimised for air return & supply ducted installations.

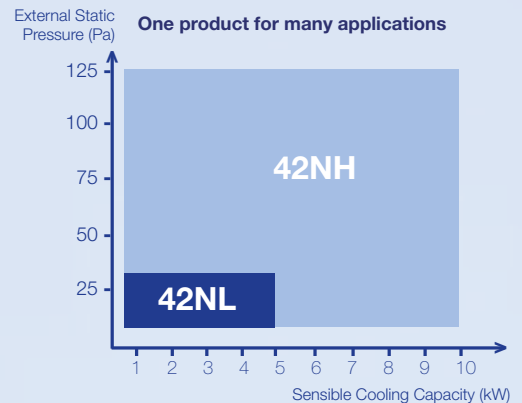

Specific solutions for specific needs

Office



■ Load variation adaptability

Conditions inside buildings change as a result of many factors including the time of the day and occupancy. Carrier solutions, equipped with precise electronic capacity controls and variable speed motors, adapt to meet load variations in just a few seconds, assuring exceptional comfort and in turn ensuring optimised energy consumption.



Hotel



■ Low noise features (night mode)

Air conditioning, ventilation and heating (depending on the region and season) are among the first things guests experience. The 42NL & 42NH range offers low noise performance to ensure a quiet and comfortable environment for hotel guests and visitors.



Hospital



■ Air quality

The 42NL & 42NH range can help to ensure and maintain a highly controlled microclimate, regulating temperature and humidity levels, as well as ensuring optimal indoor air quality (filtration efficiency levels, management of CO₂ levels).



Shops and restaurants



■ Space volume flexibility

Available in large sizes and high power configurations, the 42NL & 42NH range offers flexible solutions for managing a large space with a limited number of units.

Water Terminal Controller

Best-in-class control solutions

With Carrier's specific control algorithms, the Water Terminal Controller (WTC) combines best-in-class comfort solutions together with high energy efficiency management.

Designed for a variety of configurations and offered in a wide range of user interfaces, the WTC can fit every application and every need.

A variety of configurations for every application

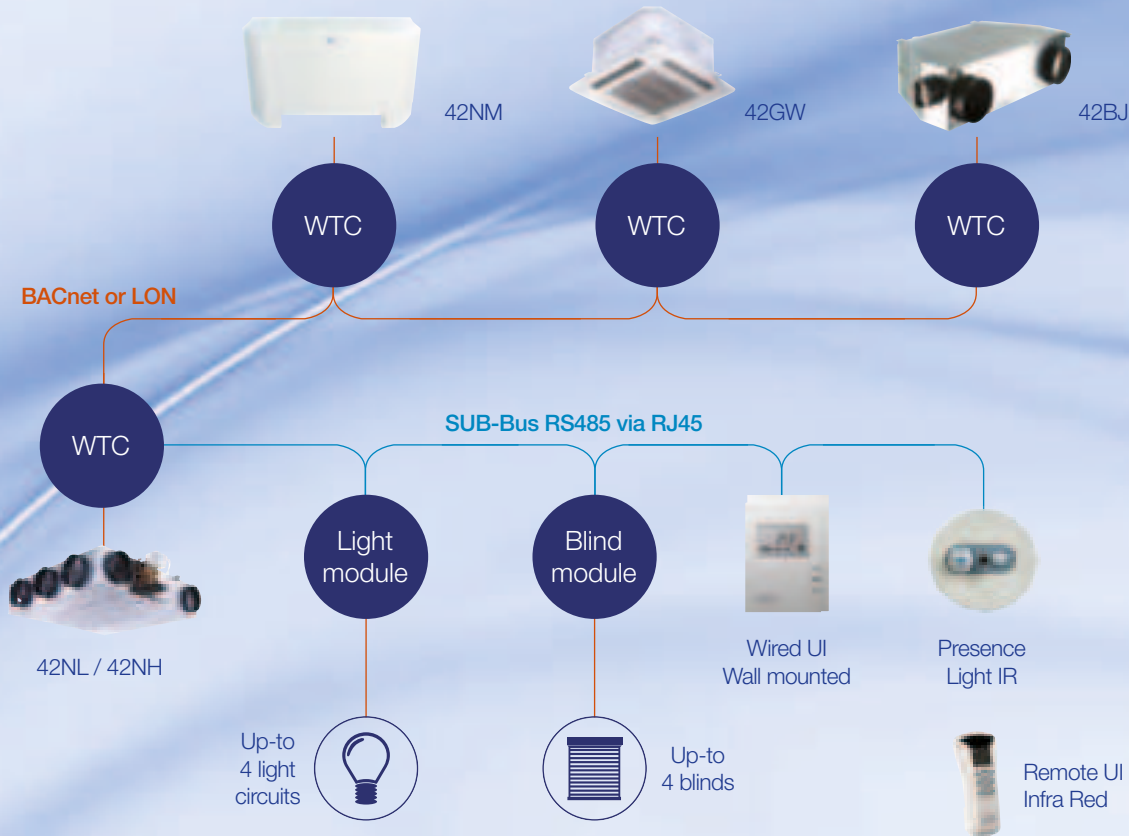

FEATURES AND ADVANTAGES

- **High efficiency:** The WTC's energy saving algorithms control fan speed and manage water valve operation in parallel, achieving optimal energy consumption whilst ensuring there is no resulting loss in comfort for occupants.
- **Easy installation:** The WTC is compatible with the full Carrier fan coil range. For customers and installers the same controller simplifies and eases installation and service operations whilst covering a wide range of hydronic system types and applications. The WTC is factory installed on the terminal fan coil before factory testing of each individual terminal. As a result, field installation is extremely simple.
- **Variety of configurations:** The controller can operate as either a standalone control, command and follow function for open spaces, or at the heart of a building management system.
- **User friendly user interface:** The user interface is available in a variety of configurations: no display, LCD display, temperature sensor, lights & blind control, etc.

ADVANCED OPTIONS

- **Low Energy Consumption (LEC) variable speed control:** The WTC can drive the fan speed continuously within a configurable range for optimal thermal and acoustic comfort.
- **Modulating hydronic control:** The WTC controls both floating and fixed-point value actuator types (230 V on-off and 230 V three point).
- **Demand controller ventilation (DCV) & IAQ management:** On fan coils equipped with CO₂ sensors and fresh air dampers, the WTC can adjust the amount of fresh air admitted to the room, as required by the occupants.
- **Lights and blind management modules:** The WTC supervises the interconnection of light modules & blinds modules, allowing the user to improve local comfort control with the same user interface as HVAC system.

A range of user interfaces to meet all needs

	Room Control Interface			Infrared Remote Interface	
					
	WTC-RCI-S	WTC-RCI-SF/SOF	WTC-RCI-D/DC/DM/DCM	WTC-IR	WTC-IR-LB
TEMPERATURE SENSOR	✓	✓	✓		
SETPOINT OFFSET		✓	✓	✓	✓
FAN SPEED	✓	✓	✓	✓	✓
WITH OR WITHOUT OCCUPANCY FUCTION		✓	✓	✓	✓
OPERATING MODE		✓	✓	✓	✓
LIGHT & BLIND CONTROL			✓		✓
POWER SUPPLY FROM WTC	✓	✓	✓		
QUICK CONNECTION	RJ45	RJ45	RJ45		
LOCAL SERVICE TOOL			✓		
WITH OR WITHOUT MOTION SENSOR			✓		
LCD DISPLAY			✓	✓	✓
INFRARED RECEIVER WITH STATUS (LED & BUZZER)				✓	
INFRARED RECEIVER					✓

Physical data



42NH (AC version*)		225			235			325			335			425			435		
		R5	R2	R1	R5	R2	R1	R4	R3	R2	R4	R3	R2	R5	R4	R3	R5	R4	R3
FAN SPEED																			
AIR FLOW	m³/h	81	228	272	81	228	272	284	366	471	284	366	471	375	537	650	375	537	650
AVAILABLE STATIC PRESSURE	Pa	6	50	71	6	50	71	30	50	83	30	50	83	24	50	73	24	50	73
COOLING MODE, TWO PIPES**																			
TOTAL COOLING CAPACITY	kW	0.48	1.22	1.42	0.54	1.42	1.66	1.27	1.55	1.87	1.57	1.98	2.48	1.93	2.65	3.08	2.12	3.10	3.73
SENSIBLE COOLING CAPACITY	kW	0.37	0.97	1.14	0.40	1.08	1.28	1.06	1.31	1.61	1.22	1.55	1.96	1.56	2.17	2.55	1.67	2.42	2.93
WATER PRESSURE DROP	kPa	3.6	17.9	23.3	3.4	13.7	18.2	9.6	13.6	19.1	9	15	23	10.5	18.5	23.9	12.8	25.6	35.3
HEATING MODE, TWO PIPES***																			
HEATING CAPACITY	kW	0.57	1.47	1.71	0.62	1.67	1.96	1.87	2.30	2.77	2.11	2.66	3.30	2.38	3.40	4.07	2.53	3.64	4.39
WATER PRESSURE DROP	kPa	4.5	19.6	25.2	3.3	15.4	20	14	19.6	26.9	13.9	20.3	29.2	12.5	22.4	30.2	15.2	27.8	38.2
COOLING MODE, FOUR PIPES**																			
TOTAL COOLING CAPACITY	kW		NA		0.44	1.07	1.24				1.58	1.94	2.34		NA		2.01	2.75	3.21
SENSIBLE COOLING CAPACITY	kW		NA		0.36	0.90	1.06			NA	1.21	1.51	1.86		NA		1.61	2.23	2.63
WATER PRESSURE DROP	kPa		NA		2.3	5.9	7.6				14.5	21	28.6		NA		14.3	24.9	32.1
HEATING MODE, FOUR PIPES****																			
HEATING CAPACITY	kW		NA		0.68	1.72	1.98		NA		2.32	2.81	3.31		NA		2.53	3.68	4.42
WATER PRESSURE DROP	kPa		NA		1.8	5.2	6.4		NA		10.2	13.8	18		NA		13.1	24.3	33.2
ELECTRIC HEATER																			
MAXIMUM CAPACITY	W	1000			1000			230V ±10% - 1PH - 50HZ 1600			1600			2000			2000		
SOUND LEVELS																			
Sound power level (return and radiated)	dB(A)	32	49	53	32	49	53	45	49	56	45	49	56	43	51	55	43	51	55
Sound power level (supply)	dB(A)	31	47	50	31	47	50	48	54	61	48	54	61	47	54	58	47	54	58
ELECTRICAL DATA, MOTOR																			
POWER INPUT	W	13	43	44	13	43	44	126	146	168	126	146	168	83	91	97	83	91	97
DIMENSIONS (BASE UNIT)																			
H X L X L	mm	235 X 520 X 680						235 X 520 X 850						235 X 520 X 1050					

42NH (AC version*)		525			535			545			635			645			735			745		
		R5	R4	R3	R5	R4	R3	R5	R4	R3	R4	R3	R2	R4	R3	R2	R3	R2	R1	R3	R2	R1
FAN SPEED																						
AIR FLOW	m³/h	767	863	924	767	863	924	767	863	925	1072	1428	1657	1072	1428	1657	1346	1918	2161	1346	1918	2161
AVAILABLE STATIC PRESSURE	Pa	40	50	57	40	50	57	40	50	57	28	50	67	28	50	67	25	50	63	25	50	63
COOLING MODE, TWO PIPES**																						
TOTAL COOLING CAPACITY	kW	3.52	3.84	4.03	4.33	4.77	5.05		NA		5.81	7.31	8.08	6.80	8.62	9.52	7.62	9.97	10.76	8.52	11.32	12.25
SENSIBLE COOLING CAPACITY	kW	2.94	3.23	3.41	3.41	3.79	4.02		NA		4.62	5.94	6.67	5.14	6.65	7.49	5.92	7.98	8.72	6.41	8.75	9.60
WATER PRESSURE DROP	kPa	28.5	32.3	35	38.2	45.3	49.6		NA		24	35	41.3	25	38.6	45.1	42.5	66.4	75.8	41.8	66.2	75.9
HEATING MODE, TWO PIPES***																						
HEATING CAPACITY	kW	4.72	5.19	5.47	5.00	5.53	5.84		NA		7.59	9.76	11.00	8.21	10.59	11.92	9.03	12.49	13.86	9.55	13.38	14.88
WATER PRESSURE DROP	kPa	36.5	43	47.1	45	53.4	58.7		NA		29.7	45.6	56	28.1	43.4	53.1	44.7	78.2	93.7	39.5	70.5	84.8
COOLING MODE, FOUR PIPES**																						
TOTAL COOLING CAPACITY	kW		NA		3.59	3.93	4.13	3.99	4.40	4.66		NA		5.38	6.63	7.22	6.29	8.28	8.99	8.11	10.46	11.18
SENSIBLE COOLING CAPACITY	kW		NA		2.96	3.25	3.43	3.23	3.58	3.81		NA		4.40	5.56	6.18	5.16	6.96	7.61	6.18	8.25	8.96
WATER PRESSURE DROP	kPa		NA		30.6	35.5	38.7	32.8	38.9	43		NA		20.9	29.9	34.4	36	56.8	65.6	47.6	72.9	81.9
HEATING MODE, FOUR PIPES****																						
HEATING CAPACITY	kW		NA		3.89	4.21	4.41	4.67	5.10	5.34		NA		6.79	8.05	8.57	8.43	11.16	12.13	10.54	13.74	14.80
WATER PRESSURE DROP	kPa		NA		8.7	9.9	10.6	10.8	12.4	13.4		NA		10.8	14.2	15.7	18.5	29.7	34.3	23.6	36.9	41.9
ELECTRIC HEATER																						
MAXIMUM CAPACITY	W	230V ±10% - 1PH - 50HZ 2000			2000			NA			3200			230V ±10% - 1PH - 50HZ 3200			3200			3200		
SOUND LEVELS																						
Sound power level (return and radiated)	dB(A)	55	56	57	55	56	57	55	56	57	56	58	61	56	58	61	57	63	64	57	63	64
Sound power level (supply)	dB(A)	55	57	59	55	57	59	55	57	59	59	62	65	59	62	65	58	66	68	58	66	68
ELECTRICAL DATA, MOTOR																						
POWER INPUT	W	105	113	117	105	113	117	105	113	117	217	225	242	217	225	242	282	316	356	282	316	356
DIMENSIONS (BASE UNIT)																						
H X L X L	mm	235 X 520 X 1250						285 X 575 X 1250						285 X 575 X 1550								

42NL (AC version*)		225			235			325			335			425			435			525			535			545		
		R6	R5	R4	R6	R5	R4	R6	R5	R4	R6	R5	R4	R6	R5	R4	R6	R5	R4	R6	R5	R4	R6	R4	R3	R6	R4	R3
FAN SPEED																												
AIR FLOW	m³/h	214	248	346	214	248	346	302	338	447	302	338	447	464	537	751	464	537	751	540	840	991	540	840	991	540	840	991
AVAILABLE STATIC PRESSURE	Pa			0			0			0			0			0			0			0			0			0
COOLING MODE, TWO PIPES**																												
TOTAL COOLING CAPACITY	kW	1.17	1.33	1.72	1.35	1.54	2.04	1.43	1.56	1.90	1.75	1.94	2.48	2.37	2.67	3.44	2.69	3.12	4.25	2.69	3.78	4.23	3.14	4.68	5.32			NA
SENSIBLE COOLING CAPACITY	kW	0.93	1.06	1.40	1.03	1.18	1.59	1.21	1.32	1.65	1.38	1.54	1.98	1.93	2.19	2.87	2.12	2.45	3.35	2.21	3.17	3.59	2.47	3.71	4.26			NA
WATER PRESSURE DROP	kPa	16.2	20.4	31.4	12.2	15.6	26.5	10.5	12.2	17.9	11.6	13.9	22	14.8	18.5	28.3	19.4	25.7	43.7	16.8	31.3	37.9	21	43.7	54			NA
HEATING MODE, TWO PIPES***																												
HEATING CAPACITY	kW	1.39	1.58	2.07	1.57	1.80	2.41	1.97	2.16	2.67	2.23	2.48	3.17	2.95	3.40	4.61	3.15	3.64	5.04	3.45	5.08	5.75	3.56	5.41	6.14			NA
WATER PRESSURE DROP	kPa	17.9	22.1	35	13.9	17.3	28.4	15.2	17.7	25.3	15.3	18.1	27.2	17.7	22.4	37.5	21.7	27.8	48.2	21.6	41.5	51.3	25.3	51.4	64			NA
COOLING MODE, FOUR PIPES**																												
TOTAL COOLING CAPACITY	kW		NA		1.02	1.16	1.51		NA		1.75	1.91	2.35		NA		2.46	2.77	3.58		NA		2.70	3.86	4.33	2.92	4.32	4.93
SENSIBLE COOLING CAPACITY	kW		NA		0.86	0.98	1.30		NA		1.37	1.50	1.88		NA		1.99	2.25	2.97		NA		2.20	3.19	3.62	2.35	3.51	4.04
WATER PRESSURE DROP	kPa		NA		5.4	6.6	10.5		NA		15.9	18.8	26.9		NA		20.1	24.9	38.5		NA		17.9	34.3	41.8	18	37.4	47
HEATING MODE, FOUR PIPES****																												
HEATING CAPACITY	kW		NA		1.63	1.84	2.36		NA		2.43	2.66	3.21		NA		3.17	3.68	5.01		NA		2.99	4.14	4.60	3.44	5.00	5.57
WATER PRESSURE DROP	kPa		NA		4.8	5.7	8.3		NA		11	12.6	17.2		NA		18.9	24.3	41.2		NA		5.9	9.6	11.4	6.8		

Physical data



42NH (EC version*)	229			239			279			289			329			339			429			439					
	2V	7V	8V	2V	7V	8V	2V	6V	7V	2V	6V	7V	2V	3.7V	4.5V	2V	3.7V	4.5V	2V	3.7V	5V	2V	3.7V	5V			
FAN SPEED																											
AIR FLOW	m³/h			91 229 253			91 229 253			116 305 349			128 347 387			213 449.9 528			212 447.2 526.5			220 418 603			220 418 603		
AVAILABLE STATIC PRESSURE	Pa			8 50 61			8 50 61			7 50 65			7 50 62			11 50 69			11 50 70			11 50 81			11 50 81		
COOLING MODE, TWO PIPES**																											
TOTAL COOLING CAPACITY	kW			0.55 1.26 1.36			0.62 1.45 1.58			0.78 1.86 2.07			1.00 2.44 2.67			1.11 1.93 2.15			1.29 2.50 2.85			1.23 2.42 2.93			1.21 2.76 3.50		
SENSIBLE COOLING CAPACITY	kW			0.43 1.00 1.09			0.46 1.11 1.22			0.59 1.44 1.61			0.71 1.79 1.97			0.92 1.68 1.89			1.01 2.00 2.29			0.99 1.98 2.42			0.99 2.17 2.74		
WATER PRESSURE DROP	kPa			4.3 18 21.1			3.7 13.8 16.2			4.7 21.9 26.9			4.4 21 25.1			6.5 18.09 21.9			6.6 22.14 28.1			4.6 15.32 21.6			4.7 20.19 31.9		
HEATING MODE, TWO PIPES***																											
HEATING CAPACITY	kW			0.64 1.48 1.61			0.70 1.68 1.84			0.88 2.17 2.44			1.05 2.78 3.09			1.46 2.68 2.99			1.61 3.16 3.61			1.35 3.00 3.80			1.45 3.19 4.08		
WATER PRESSURE DROP	kPa			5.4 19.8 22.8			3.9 15.5 18			5.7 23.7 28.9			4.9 23.3 27.8			9.4 25.45 30.7			9 27.2 34.05			5.3 18.26 26.9			6.3 22.45 33.7		
COOLING MODE, FOUR PIPES**																											
TOTAL COOLING CAPACITY	kW			NA			0.49 1.10 1.19			0.60 1.39 1.53			0.94 2.17 2.35			NA			1.22 2.97 3.35			NA			1.29 2.50 3.04		
SENSIBLE COOLING CAPACITY	kW			NA			0.41 0.93 1.01			0.50 1.19 1.32			0.68 1.66 1.81			NA			1.15 2.23 2.54			NA			1.03 2.03 2.49		
WATER PRESSURE DROP	kPa			NA			2.4 6 6.8			2.8 8.9 10.7			5.9 26 30			NA			18.9 57.3 70.75			NA			6.2 20.58 29.2		
HEATING MODE, FOUR PIPES****																											
HEATING CAPACITY	kW			NA			0.77 1.73 1.88			0.96 2.16 2.37			0.97 2.29 2.53			NA			1.82 3.20 3.51			NA			1.36 3.22 4.12		
WATER PRESSURE DROP	kPa			NA			2 5.3 5.9			2.5 7.3 8.4			2.5 7.8 9.1			NA			7 17.14 19.9			NA			5.1 19.59 29.4		
ELECTRIC HEATER																											
MAXIMUM CAPACITY	W			1000			1000			1000			230V ±10% - 1PH - 50HZ 1000			1600			1600			1600			1600		
SOUND LEVELS																											
Sound power level (return and radiated)	dB(A)			36 50 52			36 50 52			34 52 54			36 54 57			37 54 58			37 54 58			37 54 60			37 54 60		
Sound power level (supply)	dB(A)			37 51 53			37 51 53			34 55 58			35 56 59			40 59 63			40 59 63			40 62 67			40 62 67		
ELECTRICAL DATA, MOTOR																											
POWER INPUT	W			3 18 22			3 18 22			4 25 36			7 36 49			8 37 58.5			8 37 58.5			8 37 76			8 37 76		
DIMENSIONS (BASE UNIT)																											
H X L X L	mm			235 X 520 X 680			235 X 520 X 680			235 X 520 X 680			235 X 520 X 680			235 X 520 X 850			235 X 520 X 850			235 X 520 X 1050			235 X 520 X 1050		

42NH (EC version*)	529			539			549			639			649			739			749					
	2V	5V	6V	2V	5V	6V	2V	5V	6V	2V	6V	7V	2V	7V	8V	2V	7V	8V	2V	7V	8V			
FAN SPEED																								
AIR FLOW	m³/h			306 765 878			306 765 878			306 765 878			368 967 1089			323 1176 1310			445 1586 1717			445 1586 1717		
AVAILABLE STATIC PRESSURE	Pa			8 50 66			8 50 66			8 50 66			7 50 63			4 50 62			4 50 59			4 50 59		
COOLING MODE, TWO PIPES**																								
TOTAL COOLING CAPACITY	kW			1.70 3.57 3.93			1.77 4.37 4.88			NA			1.76 5.44 5.99			1.87 7.49 8.14			2.79 8.84 9.34			2.97 9.94 10.56		
SENSIBLE COOLING CAPACITY	kW			1.37 2.98 3.31			1.41 3.46 3.88			NA			1.40 4.34 4.80			1.51 5.71 6.25			2.16 6.99 7.43			2.25 7.60 8.11		
WATER PRESSURE DROP	kPa			7.2 28.4 33			7.2 38.1 46.5			NA			3.5 20.3 24.6			3.7 29.1 34.4			6.6 52.7 58.2			5.8 51.8 57.7		
HEATING MODE, TWO PIPES***																								
HEATING CAPACITY	kW			1.98 4.71 5.26			1.80 4.99 5.61			NA			2.19 6.90 7.70			2.33 8.94 9.84			3.22 10.51 11.31			3.22 11.19 12.07		
WATER PRESSURE DROP	kPa			8.8 36.4 44			8.4 44.8 54.8			NA			4.1 25.3 30.4			3.7 32.5 38.3			8.3 58 65.8			6.6 51.8 59.1		
COOLING MODE, FOUR PIPES**																								
TOTAL COOLING CAPACITY	kW			NA			1.65 3.64 4.01			1.73 4.03 4.51			NA			1.83 5.90 6.33			2.51 7.33 7.75			2.89 9.36 9.86		
SENSIBLE COOLING CAPACITY	kW			NA			1.34 3.00 3.33			1.39 3.28 3.68			NA			1.48 4.87 5.27			2.02 6.10 6.48			2.21 7.27 7.71		
WATER PRESSURE DROP	kPa			NA			7.2 30.5 36.3			6.8 32.8 40			NA			3.6 23.9 27.7			6.7 44.7 49.5			7.1 58.7 64.6		
HEATING MODE, FOUR PIPES****																								
HEATING CAPACITY	kW			NA			1.87 3.88 4.26			1.88 4.66 5.16			NA			2.17 7.22 7.70			3.07 9.65 10.28			3.36 12.02 12.75		
WATER PRESSURE DROP	kPa			NA			3.2 8.7 10.1			2.9 10.8 12.7			NA			2.3 11.9 13.2			4 23.3 25.9			4.1 29.4 32.5		
ELECTRIC HEATER																								
MAXIMUM CAPACITY	W			230V ±10% - 1PH - 50HZ 2000			2000			NA			3200			230V ±10% - 1PH - 50HZ 3200			3000			3000		
SOUND LEVELS																								
Sound power level (return and radiated)	dB(A)			35 53 57			35 53 57			35 53 57			38 58 61			38 61 64			45 60 62			45 60 62		
Sound power level (supply)	dB(A)			36 57 61			36 57 61			36 57 61			46 60 63			46 63 66			44 61 63			44 61 63		
ELECTRICAL DATA, MOTOR																								
POWER INPUT	W			9 52 78			9 52 78			9 52 78			8 76 106			9 111 153			10 137 177			10 137 177		
DIMENSIONS (BASE UNIT)																								
H X L X L	mm			235 X 520 X 1250			235 X 520 X 1250			235 X 520 X 1250			285 X 575 X 1250			285 X 575 X 1250			285 X 575 X 1550			285 X 575 X 1550		

42NL (EC version*)	229			239			329			339			429			439			529			539			549					
	2V	4V	6V	2V	5V	7V	2V	4V	6V	2V	4V	6V	2V	3.5V	4V	2V	3.5V	4V	2V	5V	6V	2V	5.5V	6V	2V	5.5V	6V			
FAN SPEED																														
AIR FLOW	m³/h			153 210 261			153 234 292			198 318 431			198 318 431			240 397 444			240 398 444			294 618 675			294 645 673			290 644.5 674		
AVAILABLE STATIC PRESSURE	Pa			0			0			0			0			0			0			0			0			0		
COOLING MODE, TWO PIPES**																														
TOTAL COOLING CAPACITY	kW			0.89 1.17 1.41			1.00 1.48 1.81			1.05 1.52 1.89			1.21 1.87 2.44			1.33 2.09 2.31			1.34 2.32 2.60			1.65 3.04 3.26			1.70 3.78 3.93			NA		
SENSIBLE COOLING CAPACITY	kW			0.70 0.94 1.14			0.76 1.14 1.40			0.87 1.29 1.64			0.95 1.48 1.95			1.08 1.71 1.89			1.09 1.84 2.05			1.33 2.52 2.71			1.36 2.98 3.10			NA		
WATER PRESSURE DROP	kPa			9.4 15.7 22.1			7 14.1 20.3			5.9 11.2 17			5.9 12.6 20.7			5.3 11.5 13.8			5.4 14.3 17.7			6.8 20.6 23.5			6.7 29.1 31.5			NA		
HEATING MODE, TWO PIPES***																														
HEATING CAPACITY	kW			1.03 1.37 1.65			1.13 1.70 2.08			1.37 2.05 2.60			1.50 2.34 3.06			1.49 2.52 2.82			1.59 2.68 3.00			1.90 3.90 4.22			1.70 4.26 4.44			NA		
WATER PRESSURE DROP	kPa			11 17.5 23.8			8.3 15.8 22.2			8.5 16.3 24.1			8.2 16.5 25.7			6.1 13.6 16.4			7.3 16.7 20.1			8.3 26.5 30.3			7.6 34.2 36.7			NA		
COOLING MODE, FOUR PIPES**																														
TOTAL COOLING CAPACITY	kW			NA			0.76 1.12 1.35			NA			1.27 1.87 2.36			NA			1.40 2.18 2.40			NA			1.59 3.19 3.31			1.64 3.49 3.63		
SENSIBLE COOLING CAPACITY	kW			NA			0.65 0.96 1.16			NA			0.98 1.47 1.89			NA			1.11 1.76 1.94			NA			1.29 2.62 2.72			1.33 2.83 2.94		
WATER PRESSURE DROP	kPa			NA			3.4 6.1 8.3			NA			8 16 25			NA			7 15.6 18.6			NA			6.7 24 25.7			6.3 24.65 26.6		
HEATING MODE, FOUR PIPES****																														
HEATING CAPACITY	kW			NA			1.21 1.75 2.09			NA			1.95 2.90 3.58			NA			1.50 2.68 3.02			NA			1.80 3.43 3.54			1.76 4.04 4.20		
WATER PRESSURE DROP	kPa			NA			3.3 5.4 6.9			NA			7 13 19			NA			5.9 14.4 17.5			NA			3 7.2 7.6			2.7 8.65 9.2		
ELECTRIC HEATER																														
MAXIMUM CAPACITY	W			1000			1000			1600			230V ±10% - 1PH - 50HZ 1600			1600			1600			2000			2000			NA		
SOUND LEVELS																														
Sound power level (global)	dB(A)			32 37 40			32 38 41			37 46 53			37 46 53			38 49 52			38 49 52			32 47 51			32 49 51			32 49 51		
ELECTRICAL DATA, MOTOR																														
POWER INPUT	W			3 5 7			3 5 9			4 10 20			4 10 20			6 15 18			6 15 18			4 18 24			4 21 24			4 21 24		
DIMENSIONS (BASE UNIT)																														
H X L X L	mm			235 X 520 X 680			235 X 520 X 680			235 X 520 X 850			235 X 520 X 850			235 X 520 X 1050			235 X 520 X 1050			235 X 520 X 1250			235 X 520 X 1250					

(EC version) *Please contact your sales representative for AC version physical data.

** Eurovent conditions: Entering air temperature = 27°C db/47% rh - entering water temperature = 7°C, water temperature difference = 5 K.

*** Eurovent conditions: Entering air temperature = 20°C, entering water temperature = 45°C, water temperature difference = 5K

**** Eurovent conditions: Entering air temperature = 20°C, entering water temperature = 65°C, water temperature difference = 10 K.

www.carrier.com

Ildofan - English - March 2020. © Carrier 2020. All rights reserved.

Carrier reserves the right to change certain information and specifications contained in this document at any time and without prior notice.

Since standards, specifications and designs are subject to occasional change, please ask for confirmation of the information given in this publication.

